

COVER AIR LOW - PITCHING

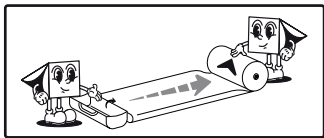

A.

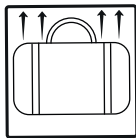
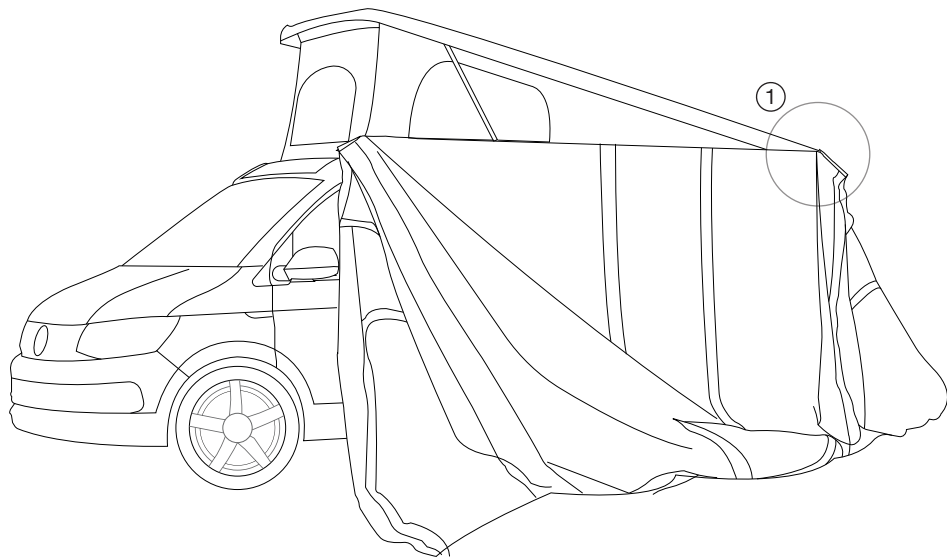

①

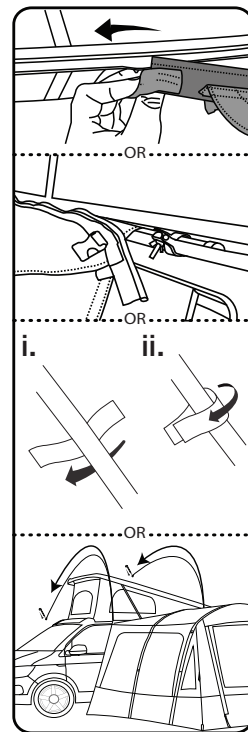

B.

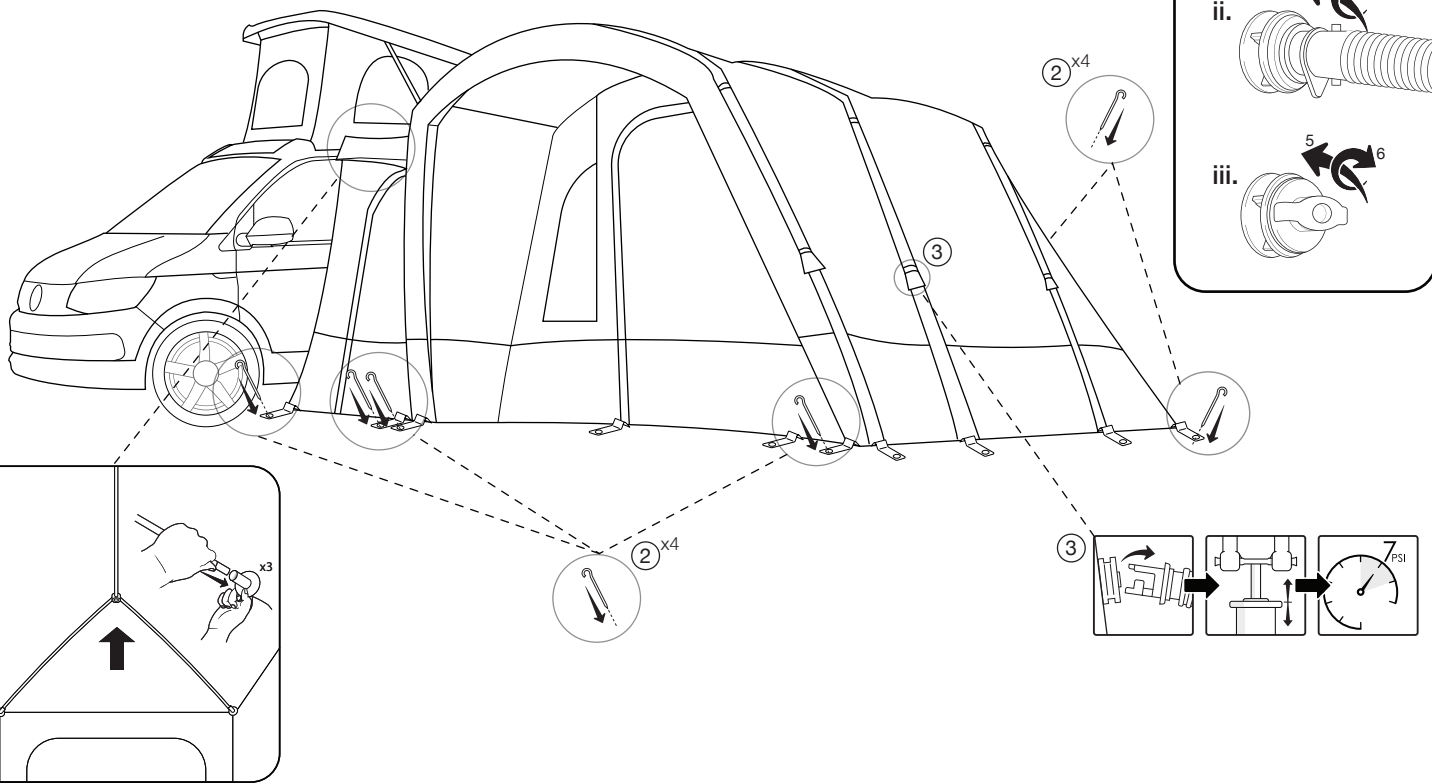

C.

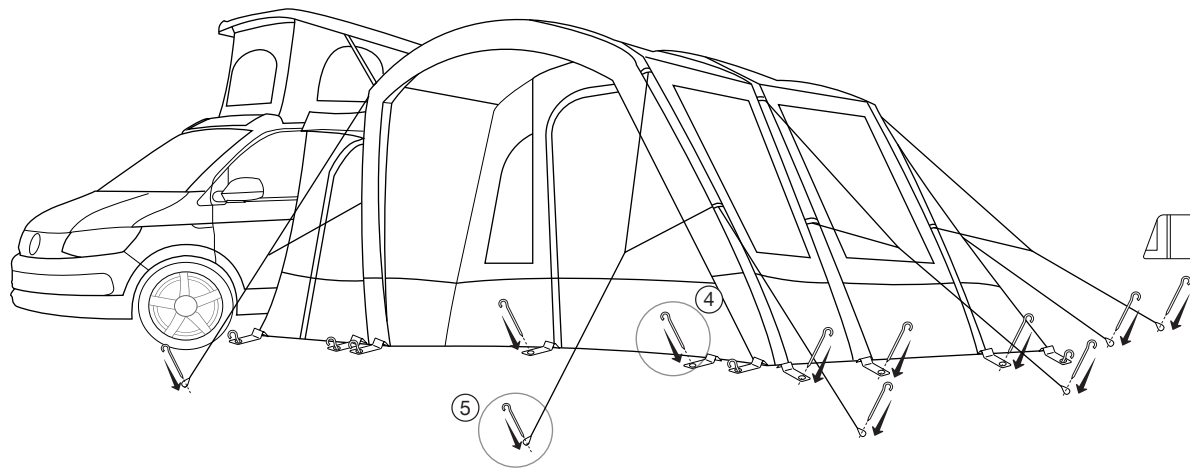

TBS® II

i.



ii.

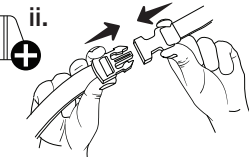

iii.

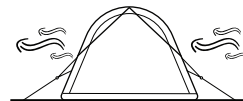

COVE AIR LOW - PACKING

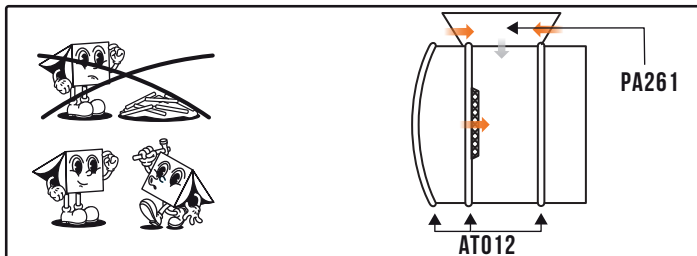
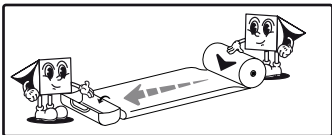
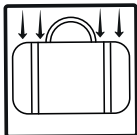

A.

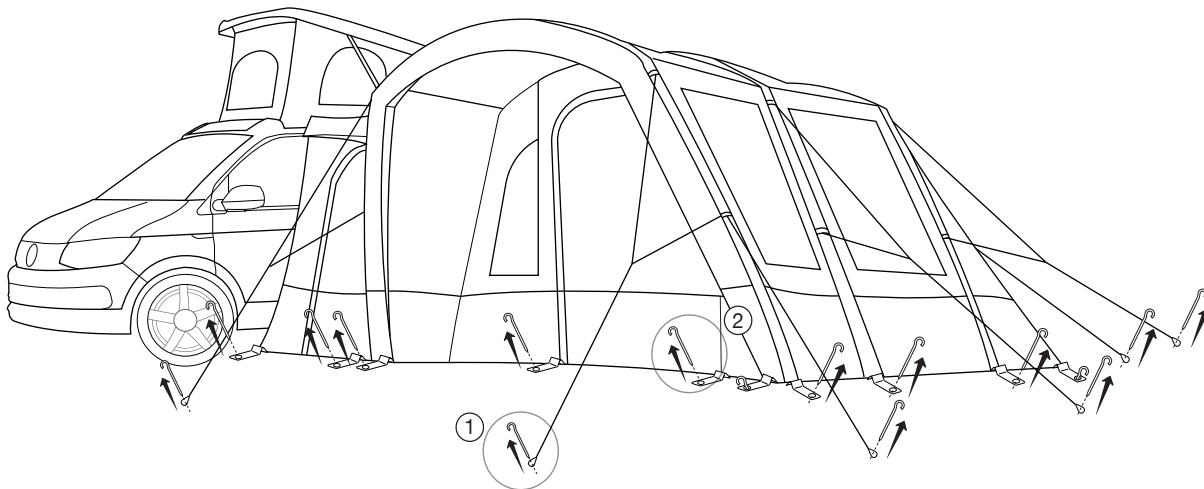

B.

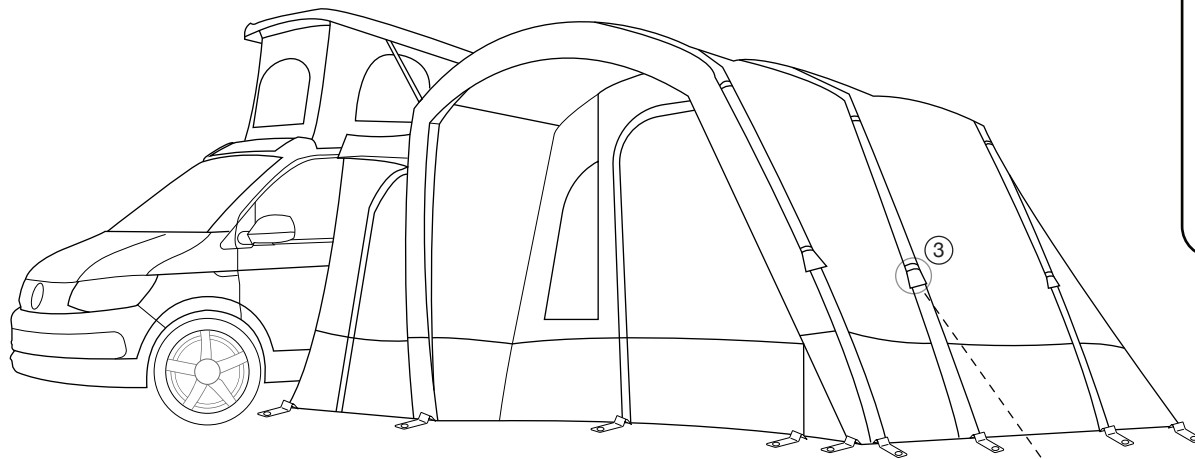

3

- i.
- ii.
- iii.

3



C.

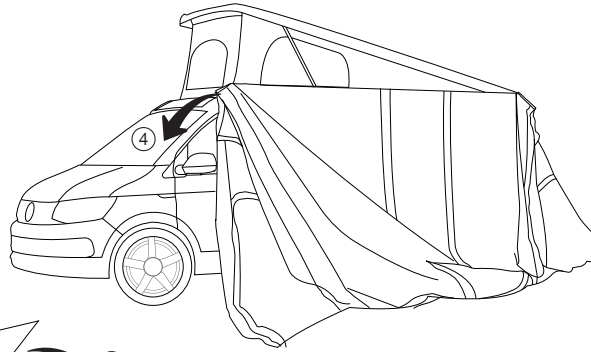

D.

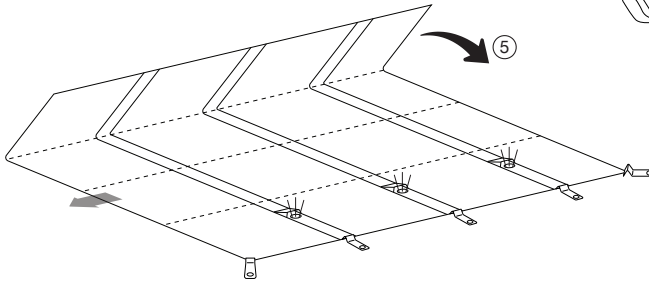

E.

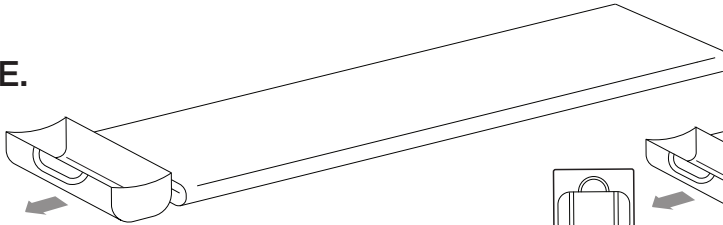

F.

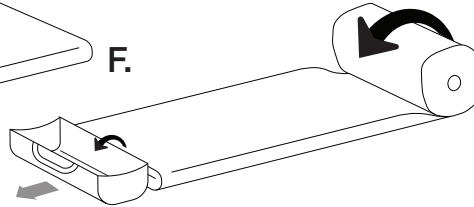

4

